

Parallel Terminal

» *Always for your safety*

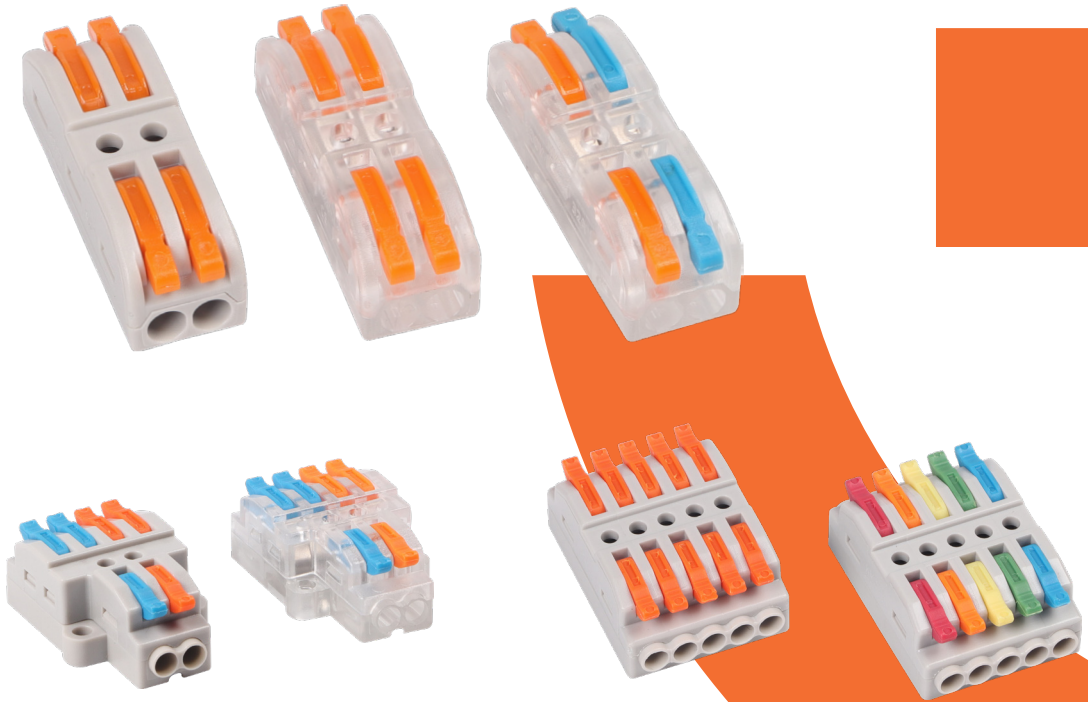

Always for your safety



RoHS

COMPANY INTRODUCTION

Zhejiang ETEK Electric Technology Co., Ltd. (Abbreviation: ETEK Electric) is a professional manufacturing company dedicated to the research, development, production and sales of low-voltage electrical appliances. The company was established in 2011 and is located in Wenzhou City, Zhejiang Province. At present, the company has a modern factory building of more than 12,000 mm². ETEK Electric focuses on the low-voltage electrical fieldwide and has advanced production management systems and production processes. Its products cover electrical safety products for household, commercial, industrial and similar facilities, such as Miniature Circuit Breakers (MCB), Residual Current Devices (RCD), Isolating Switches, Molded Case Circuit Breakers (MCCB), Distribution Board, AC Contactors, Surge Protectors (SPD), IoT Smart Circuit Breakers and Electric Vehicle Charging Facilities (EV Charger), etc.

Relying on hard work and innovation, ETEK Electric's products quickly stand out in the fiercely competitive electrical market. With its own brand 'ETEK', it has successfully entered the international market and signed overseas brand agency contracts with customers from many countries and regions. Its products are exported to the Europe, Middle East, Africa, South Asia and other more than 60 countries and regions.

ETEK Electric always insists on providing customers with safe and reliable electrical products. Won approvals of CE, CB, TUV, UKCA, SEMKO, VDE, SAA and ISO9001 Quality System Certificate and RoHS Environmental Management System Certificate.

ETEK Electric is committed to solving the pressure and challenges of customers and creating value for customers. ETEK Electric has rich industry experience and a dynamic, professional and efficient team, we can provide customers with the best OEM, ODM services.

Growth, Efficiency, Innovation and Quality are ETEK's business goals. We are firmly committed to the field of low voltage electrical products which is your trusted partner.

We hope our products can guarantee the power safety of global users and promote the development of green energy.



WORKSHOPS

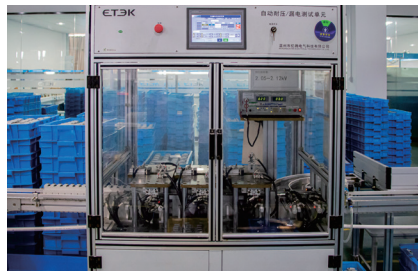

TESTING CENTER

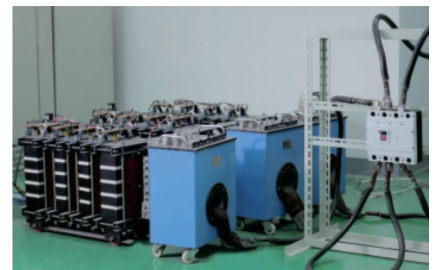

Parallel Terminal

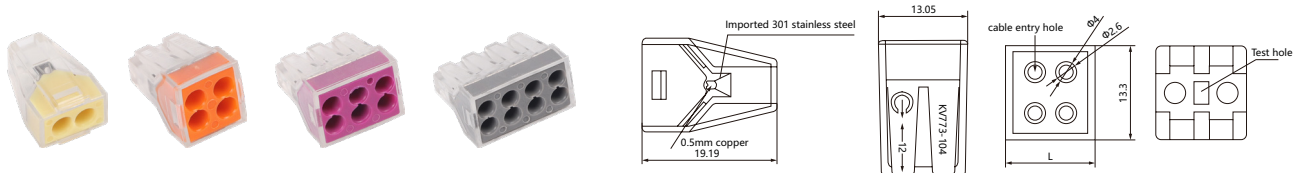

Reference No.	Color: Body case	Color: Terminal position	Hole	Amper	Voltage	Wire(mm ²)	L(mm)
KV773-102TY	Transparent	Yellow	2	20	600VAC	1.6-2	13.3
KV773-104TO	Transparent	Orange	4	20	600VAC	1.6-2	13.3
KV773-106TP	Transparent	Purple	6	20	600VAC	1.6-2	18.5
KV773-108TG	Transparent	Gray	8	20	600VAC	1.6-2	24

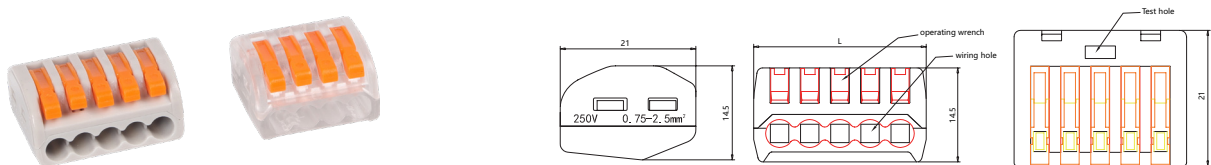

Reference No.	Color: Body case	Color: Terminal position	Hole	Amper	Voltage	Wire(mm ²)	L(mm)
KV222-412GO	Gray	Orange	2	32	250VAC	0.75-4	12.5
KV222-412TO	Transparent	Orange	2	32	250VAC	0.75-4	12.5
KV222-413GO	Gray	Orange	3	32	250VAC	0.75-4	17.1
KV222-413TO	Transparent	Orange	3	32	250VAC	0.75-4	17.1
KV222-414GO	Gray	Orange	4	32	250VAC	0.75-4	21.6
KV222-414TO	Transparent	Orange	4	32	250VAC	0.75-4	21.6
KV222-415GO	Gray	Orange	5	32	250VAC	0.75-4	26.9
KV222-415TO	Transparent	Orange	5	32	250VAC	0.75-4	26.9
KV222-418GO	Gray	Orange	8	32	250VAC	0.75-4	40.2
KV222-418TO	Transparent	Orange	8	32	250VAC	0.75-4	40.2

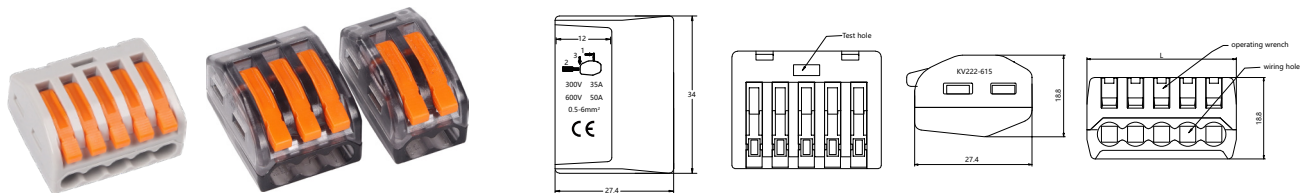

Reference No.	Color: Body case	Color: Terminal position	Hole	Amper	Voltage	Wire(mm ²)	L(mm)
KV222-612GO	Gray	Orange	2	50	600VAC	0.5-6	16
KV222-612BTO	Black/Transparent	Orange	2	50	600VAC	0.5-6	16
KV222-613GO	Gray	Orange	3	50	600VAC	0.5-6	22
KV222-613BTO	Black/Transparent	Orange	3	50	600VAC	0.5-6	22
KV222-615GO	Gray	Orange	5	50	600VAC	0.5-6	34
KV222-615BTO	Black/Transparent	Orange	5	50	600VAC	0.5-6	34

Parallel Terminal

Standard_ IEC455(1988)

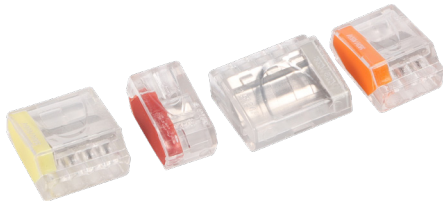

KV252TR KV253TO KV254TY KV255TG

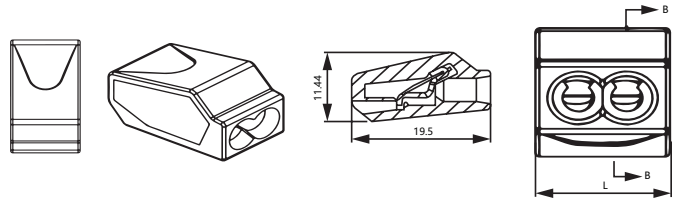

Reference No.	Color: Body case	Color: Terminal position	Hole	Amper	Voltage	Wire(mm ²)	L(mm)
KV252TR	Transparent	Red	2	24	300/600VAC	0.75-2.5	10.15
KV253TO	Transparent	Orange	3	24	300/600VAC	0.75-2.5	13.8
KV254TY	Transparent	Yellow	4	24	300/600VAC	0.75-2.5	17.45
KV255TG	Transparent	Gray	5	24	300/600VAC	0.75-2.5	21.1

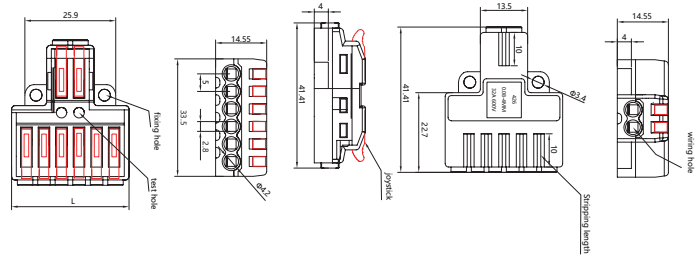
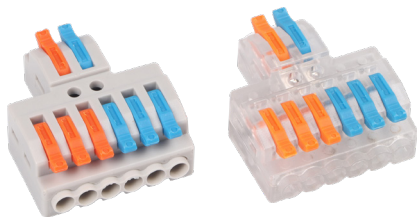

Reference No.	Color: Body case	Color: Terminal position	Hole	Amper	Voltage	Wire(mm ²)	L(mm)
KV424GC	Gray	Colours	6	32	600VAC	0.08-4	26
KV424TC	Transparent	Colours	6	32	600VAC	0.08-4	26
KV426GC	Gray	Colours	8	32	600VAC	0.08-4	33.5
KV426TC	Transparent	Colours	8	32	600VAC	0.08-4	33.5
KV436GC	Gray	Colours	9	32	600VAC	0.08-4	35.9
KV436TC	Transparent	Colours	9	32	600VAC	0.08-4	35.9
KV439GC	Gray	Colours	12	32	600VAC	0.08-4	48.5
KV439TC	Transparent	Colours	12	32	600VAC	0.08-4	48.5

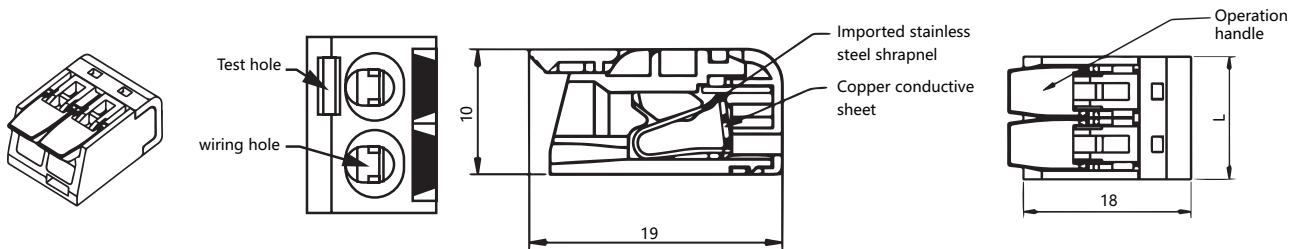

Reference No.	Color: Body case	Color: Terminal position	Hole	Amper	Voltage	Wire(mm ²)	L(mm)
KV221-412TG	Transparent	Green	2	32	600VAC	0.14-4	13
KV221-413TG	Transparent	Green	3	32	600VAC	0.14-4	18.5
KV221-414TG	Transparent	Green	4	32	600VAC	0.14-4	24
KV221-415TG	Transparent	Green	5	32	600VAC	0.14-4	30
KV221-412TB	Transparent	Blue	2	32	600VAC	0.14-4	13
KV221-413TB	Transparent	Blue	3	32	600VAC	0.14-4	18.5
KV221-414TB	Transparent	Blue	4	32	600VAC	0.14-4	24
KV221-415TB	Transparent	Blue	5	32	600VAC	0.14-4	30
KV221-412TO	Transparent	Orange	2	32	600VAC	0.14-4	13
KV221-413TO	Transparent	Orange	3	32	600VAC	0.14-4	18.5
KV221-414TO	Transparent	Orange	4	32	600VAC	0.14-4	24
KV221-415TO	Transparent	Orange	5	32	600VAC	0.14-4	30
KV221-412TP	Transparent	Pink	2	32	600VAC	0.14-4	13
KV221-413TP	Transparent	Pink	3	32	600VAC	0.14-4	18.5
KV221-414TP	Transparent	Pink	4	32	600VAC	0.14-4	24
KV221-415TP	Transparent	Pink	5	32	600VAC	0.14-4	30
KV221-412TY	Transparent	Yellow	2	32	600VAC	0.14-4	13
KV221-413TY	Transparent	Yellow	3	32	600VAC	0.14-4	18.5
KV221-414TY	Transparent	Yellow	4	32	600VAC	0.14-4	24
KV221-415TY	Transparent	Yellow	5	32	600VAC	0.14-4	30
KV221-412TW	Transparent	White	2	32	600VAC	0.14-4	13
KV221-413TW	Transparent	White	3	32	600VAC	0.14-4	18.5
KV221-414TW	Transparent	White	4	32	600VAC	0.14-4	24
KV221-415TW	Transparent	White	5	32	600VAC	0.14-4	30

Parallel Terminal

Standard_ IEC455(1988)

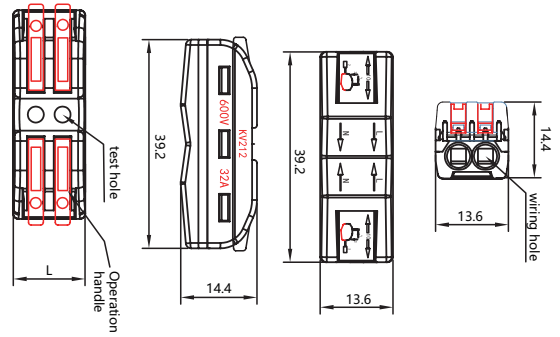
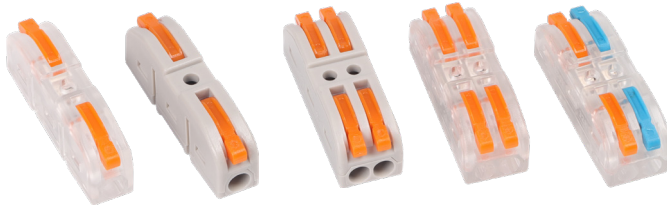

Reference No.	Color: Body case	Color: Terminal position	Hole	Amper	Voltage	Wire(mm ²)	L(mm)
KV211GO	Gray	Orange	2	32	600VAC	0.2-4	8.5
KV211TO	Transparent	Orange	2	32	600VAC	0.2-4	8.5
KV212GO	Gray	Orange	4	32	600VAC	0.2-4	13.6
KV212TO	Transparent	Orange	4	32	600VAC	0.2-4	13.6
KV212TC	Transparent	Colours	4	32	600VAC	0.2-4	13.6
KV313GO	Gray	Orange	6	32	600VAC	0.2-4	18.8
KV313TO	Transparent	Orange	6	32	600VAC	0.2-4	18.8
KV313TC	Transparent	Colours	6	32	600VAC	0.2-4	18.8

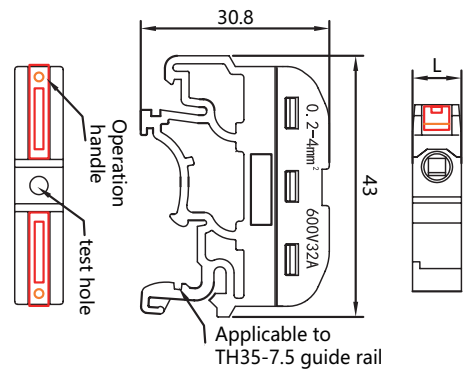

Reference No.	Color: Body case	Color: Terminal position	Hole	Amper	Voltage	Wire(mm ²)	L(mm)
KV121BO	Black	Orange	2	32	600VAC	0.2-4	8.2
KV121GO	Green	Orange	2	32	600VAC	0.2-4	8.2
KV121BUO	Blue	Orange	2	32	600VAC	0.2-4	8.2
KV121GO	Gray	Orange	2	32	600VAC	0.2-4	8.2
KV121OB	Orange	Black	2	32	600VAC	0.2-4	8.2
KV121TO	Transparent	Orange	2	32	600VAC	0.2-4	8.2

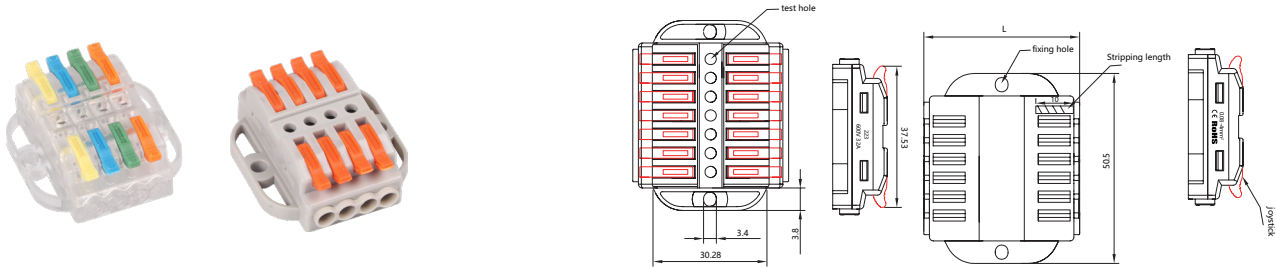

Reference No.	Color: Body case	Color: Terminal position	Hole	Amper	Voltage	Wire(mm ²)	L(mm)
KV223A-2PGO	Gray	Orange	4	32	600VAC	0.08-4	25.5
KV223A-3PGO	Gray	Orange	6	32	600VAC	0.08-4	30.5
KV223A-4PGO	Gray	Orange	8	32	600VAC	0.08-4	35.5
KV223A-5PGO	Gray	Orange	10	32	600VAC	0.08-4	40.5
KV223A-6PGO	Gray	Orange	12	32	600VAC	0.08-4	45.5
KV223A-7PGO	Gray	Orange	14	32	600VAC	0.08-4	50.5
KV223A-8PGO	Gray	Orange	16	32	600VAC	0.08-4	55.5
KV223A-9PGO	Gray	Orange	18	32	600VAC	0.08-4	60.5
KV223A-10PGO	Gray	Orange	20	32	600VAC	0.08-4	65.5
KV223A-11PGO	Gray	Orange	22	32	600VAC	0.08-4	70.5
KV223A-12PGO	Gray	Orange	24	32	600VAC	0.08-4	75.5
KV223A-14PGO	Gray	Orange	28	32	600VAC	0.08-4	85.5
KV223A-16PGO	Gray	Orange	32	32	600VAC	0.08-4	95.5
KV223A-18PGO	Gray	Orange	36	32	600VAC	0.08-4	105.5
KV223A-20PGO	Gray	Orange	40	32	600VAC	0.08-4	115.5
KV223A-30PGO	Gray	Orange	60	32	600VAC	0.08-4	165.5
KV223A-40PGO	Gray	Orange	80	32	600VAC	0.08-4	215.5
KV223A-2PTO	Transparent	Orange	4	32	600VAC	0.08-4	25.5
KV223A-3PTO	Transparent	Orange	6	32	600VAC	0.08-4	30.5
KV223A-4PTO	Transparent	Orange	8	32	600VAC	0.08-4	35.5
KV223A-5PTO	Transparent	Orange	10	32	600VAC	0.08-4	40.5
KV223A-6PTO	Transparent	Orange	12	32	600VAC	0.08-4	45.5
KV223A-7PTO	Transparent	Orange	14	32	600VAC	0.08-4	50.5
KV223A-8PTO	Transparent	Orange	16	32	600VAC	0.08-4	55.5
KV223A-9PTO	Transparent	Orange	18	32	600VAC	0.08-4	60.5
KV223A-10PTO	Transparent	Orange	20	32	600VAC	0.08-4	65.5
KV223A-11PTO	Transparent	Orange	22	32	600VAC	0.08-4	70.5
KV223A-12PTO	Transparent	Orange	24	32	600VAC	0.08-4	75.5
KV223A-14PTO	Transparent	Orange	28	32	600VAC	0.08-4	85.5
KV223A-16PTO	Transparent	Orange	32	32	600VAC	0.08-4	95.5
KV223A-18PTO	Transparent	Orange	36	32	600VAC	0.08-4	105.5
KV223A-20PTO	Transparent	Orange	40	32	600VAC	0.08-4	115.5
KV223A-30PTO	Transparent	Orange	60	32	600VAC	0.08-4	165.5
KV223A-40PTO	Transparent	Orange	80	32	600VAC	0.08-4	215.5
KV223A-2PGC	Gray	Colours	4	32	600VAC	0.08-4	25.5
KV223A-3PGC	Gray	Colours	6	32	600VAC	0.08-4	30.5
KV223A-4PGC	Gray	Colours	8	32	600VAC	0.08-4	35.5
KV223A-2PTC	Transparent	Colours	4	32	600VAC	0.08-4	25.5
KV223A-3PTC	Transparent	Colours	6	32	600VAC	0.08-4	30.5
KV223A-4PTC	Transparent	Colours	8	32	600VAC	0.08-4	35.5

Parallel Terminal

Standard_ IEC455(1988)

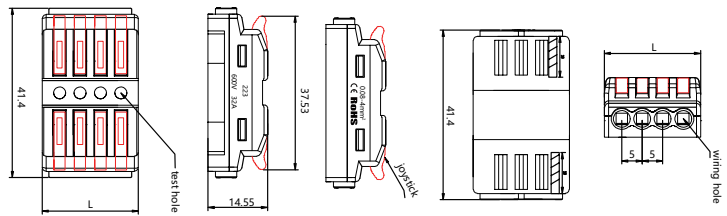
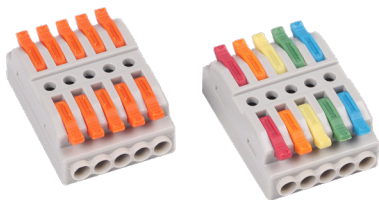

Reference No.	Color: Body case	Color: Terminal position	Hole	Amper	Voltage	Wire(mm ²)	L(mm)
KV223B-2PGO	Gray	Orange	4	32	600VAC	0.08-4	13.5
KV223B-2PGC	Gray	Colours	4	32	600VAC	0.08-4	13.5
KV223B-3PGO	Gray	Orange	6	32	600VAC	0.08-4	18.5
KV223B-3PGC	Gray	Colours	6	32	600VAC	0.08-4	18.5
KV223B-4PGO	Gray	Orange	8	32	600VAC	0.08-4	23.5
KV223B-4PGC	Gray	Colours	8	32	600VAC	0.08-4	23.5
KV223B-5PGO	Gray	Orange	10	32	600VAC	0.08-4	28.5
KV223B-5PGC	Gray	Colours	10	32	600VAC	0.08-4	28.5
KV223B-6PGO	Gray	Orange	12	32	600VAC	0.08-4	33.5
KV223B-8PGO	Gray	Orange	16	32	600VAC	0.08-4	43.5
KV223B-10PGO	Gray	Orange	20	32	600VAC	0.08-4	53.5

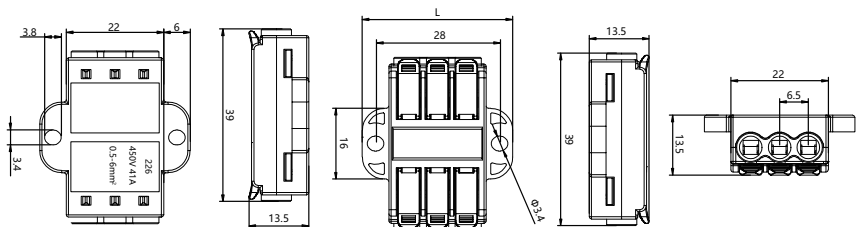
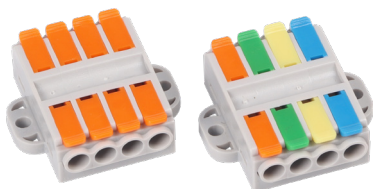

Reference No.	Color: Body case	Color: Terminal position	Hole	Amper	Voltage	Wire(mm ²)	L(mm)
KV226A-2PGO	Gray	Orange	4	41	450VAC	0.5-6	27.5
KV226A-2PGC	Gray	Colours	4	41	450VAC	0.5-6	27.5
KV226A-3PGO	Gray	Orange	6	41	450VAC	0.5-6	34
KV226A-3PGC	Gray	Colours	6	41	450VAC	0.5-6	34
KV226A-4PGO	Gray	Orange	8	41	450VAC	0.5-6	40.5
KV226A-4PGC	Gray	Colours	8	41	450VAC	0.5-6	40.5
KV226A-5PGO	Gray	Orange	10	41	450VAC	0.5-6	47
KV226A-5PGC	Gray	Colours	10	41	450VAC	0.5-6	47
KV226A-6PGO	Gray	Orange	12	41	450VAC	0.5-6	53.5
KV226A-6PGC	Gray	Colours	12	41	450VAC	0.5-6	53.5
KV226A-8PGO	Gray	Orange	12	41	450VAC	0.5-6	66.5
KV226A-10PGO	Gray	Orange	12	41	450VAC	0.5-6	79.5
KV226A-12PGO	Gray	Orange	12	41	450VAC	0.5-6	92.5

Parallel Terminal

Standard_ IEC455(1988)

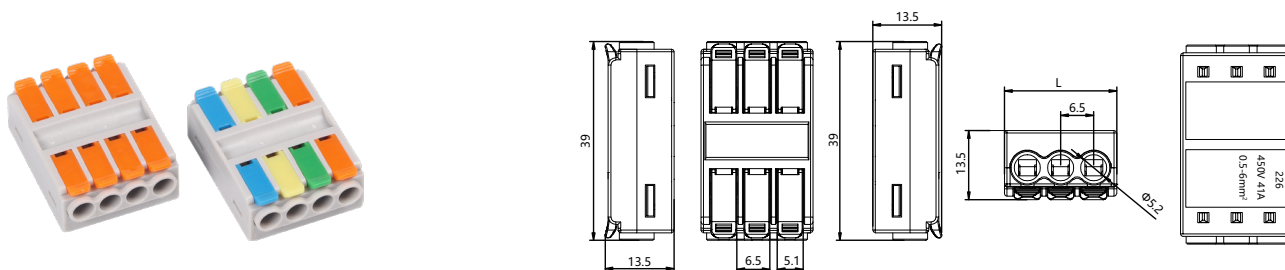

Reference No.	Color: Body case	Color: Terminal position	Hole	Amper	Voltage	Wire(mm ²)	L(mm)
KV226B-2PGO	Gray	Orange	2	41	450VAC	0.5-6	15.5
KV226B-2PGC	Gray	Colours	2	41	450VAC	0.5-6	15.5
KV226B-3PGO	Gray	Orange	6	41	450VAC	0.5-6	22
KV226B-3PGC	Gray	Colours	6	41	450VAC	0.5-6	22
KV226B-4PGO	Gray	Orange	8	41	450VAC	0.5-6	28.5
KV226B-4PGC	Gray	Colours	8	41	450VAC	0.5-6	28.5
KV226B-5PGO	Gray	Orange	10	41	450VAC	0.5-6	35
KV226B-5PGC	Gray	Colours	10	41	450VAC	0.5-6	35
KV226B-6PGO	Gray	Orange	12	41	450VAC	0.5-6	41.5
KV226B-6PGC	Gray	Colours	12	41	450VAC	0.5-6	41.5

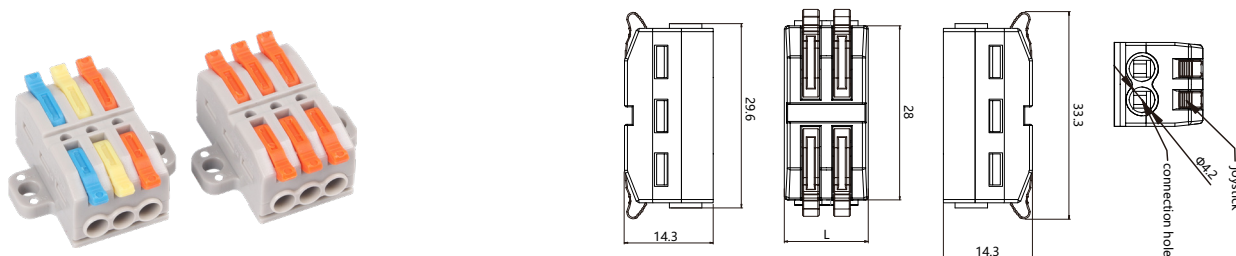

Reference No.	Color: Body case	Color: Terminal position	Hole	Amper	Voltage	Wire(mm ²)	L(mm)
KV227A-2PGO	Gray	Orange	4	32	250VAC	0.08-4	13.5
KV227A-2PGC	Gray	Colours	4	32	250VAC	0.08-4	13.5
KV227A-3PGO	Gray	Orange	6	32	250VAC	0.08-4	18.5
KV227A-3PGC	Gray	Colours	6	32	250VAC	0.08-4	18.5
KV227A-4PGO	Gray	Orange	8	32	250VAC	0.08-4	23.5
KV227A-5PGO	Gray	Orange	10	32	250VAC	0.08-4	28.5
KV227A-6PGO	Gray	Orange	12	32	250VAC	0.08-4	33.5
KV227A-8PGO	Gray	Orange	16	32	250VAC	0.08-4	43.5
KV227A-10PGO	Gray	Orange	20	32	250VAC	0.08-4	53.5
KV227A-12PGO	Gray	Orange	24	32	250VAC	0.08-4	63.5

Parallel Terminal

Standard_ IEC455(1988)

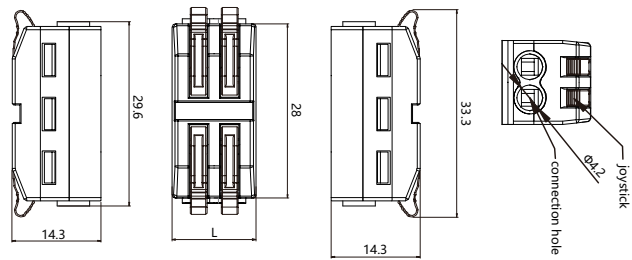
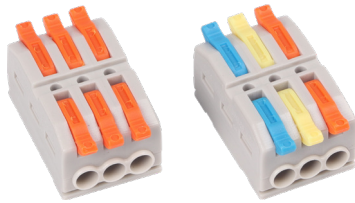

Reference No.	Color: Body case	Color: Terminal position	Hole	Amper	Voltage	Wire(mm ²)	L(mm)
KV227B-2PGO	Gray	Orange	4	32	250VAC	0.08-4	13.5
KV227B-2PGC	Gray	Colours	4	32	250VAC	0.08-4	13.5
KV227B-3PGO	Gray	Orange	6	32	250VAC	0.08-4	18.5
KV227B-3PGC	Gray	Colours	6	32	250VAC	0.08-4	18.5
KV227B-4PGO	Gray	Orange	8	32	250VAC	0.08-4	23.5
KV227B-5PGO	Gray	Orange	10	32	250VAC	0.08-4	28.5
KV227B-6PGO	Gray	Orange	12	32	250VAC	0.08-4	33.5
KV227B-8PGO	Gray	Orange	16	32	250VAC	0.08-4	43.5
KV227B-10PGO	Gray	Orange	20	32	250VAC	0.08-4	53.5
KV227B-12PGO	Gray	Orange	24	32	250VAC	0.08-4	63.5
KV227B-20PGO	Gray	Orange	40	32	250VAC	0.08-4	103.5

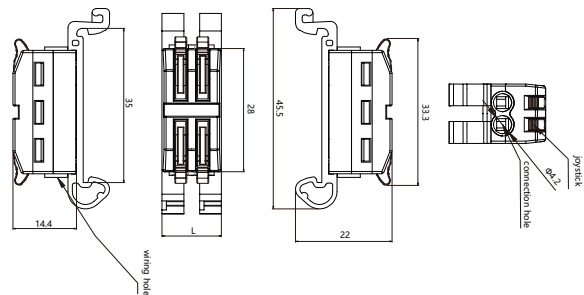
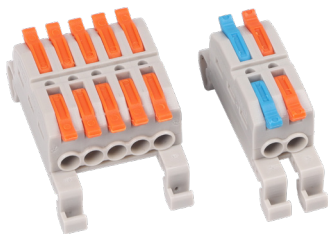

Reference No.	Color: Body case	Color: Terminal position	Hole	Amper	Voltage	Wire(mm ²)	L(mm)
KV227G-2PGO	Gray	Orange	4	32	250VAC	0.08-4	13.5
KV227G-2PGC	Gray	Coulores	4	32	250VAC	0.08-4	13.5
KV227G-3PGO	Gray	Orange	6	32	250VAC	0.08-4	18.5
KV227G-3PGC	Gray	Coulores	6	32	250VAC	0.08-4	18.5
KV227G-4PGO	Gray	Orange	8	32	250VAC	0.08-4	23.5
KV227G-5PGO	Gray	Orange	10	32	250VAC	0.08-4	28.5
KV227G-6PGO	Gray	Orange	12	32	250VAC	0.08-4	33.5
KV227G-8PGO	Gray	Orange	16	32	250VAC	0.08-4	43.5
KV227G-10PGO	Gray	Orange	20	32	250VAC	0.08-4	53.5
KV227G-12PGO	Gray	Orange	24	32	250VAC	0.08-4	63.5
KV227G-20PGO	Gray	Orange	40	32	250VAC	0.08-4	103.5

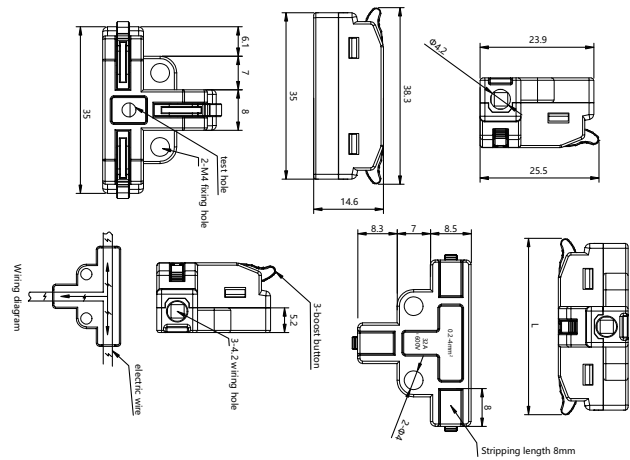

Reference No.	Color: Body case	Color: Terminal position	Hole	Amper	Voltage	Wire(mm ²)	L(mm)
KVT3GO	Gray	Orange	3	32	600VAC	0.2-4	38.3
KVT3GB	Gray	Blue	3	32	600VAC	0.2-4	38.3
KVT3GY	Gray	Yellow	3	32	600VAC	0.2-4	38.3
KVT3GR	Gray	Red	3	32	600VAC	0.2-4	38.3
KVT3TO	Transparency	Orange	3	32	600VAC	0.2-4	38.3
KVT3TB	Transparency	Blue	3	32	600VAC	0.2-4	38.3
KVT3TY	Transparency	Yellow	3	32	600VAC	0.2-4	38.3
KVT3TR	Transparency	Red	3	32	600VAC	0.2-4	38.3

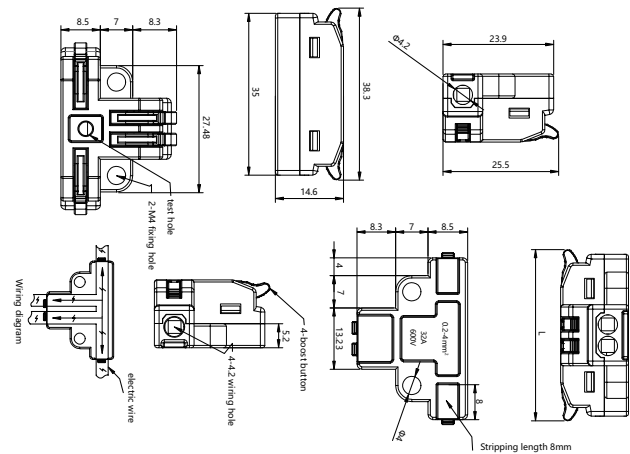
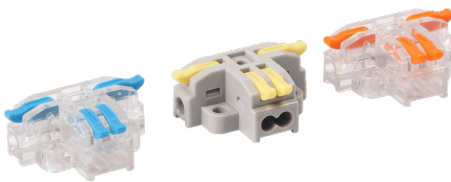

Reference No.	Color: Body case	Color: Terminal position	Hole	Amper	Voltage	Wire(mm ²)	L(mm)
KVT4GO	Gray	Orange	4	32	600VAC	0.2-4	38.3
KVT4GB	Gray	Blue	4	32	600VAC	0.2-4	38.3
KVT4GY	Gray	Yellow	4	32	600VAC	0.2-4	38.3
KVT4GR	Gray	Red	4	32	600VAC	0.2-4	38.3
KVT4TO	Transparency	Orange	4	32	600VAC	0.2-4	38.3
KVT4TB	Transparency	Blue	4	32	600VAC	0.2-4	38.3
KVT4TY	Transparency	Yellow	4	32	600VAC	0.2-4	38.3
KVT4TR	Transparency	Red	4	32	600VAC	0.2-4	38.3

Parallel Terminal

Standard_ IEC455(1988)

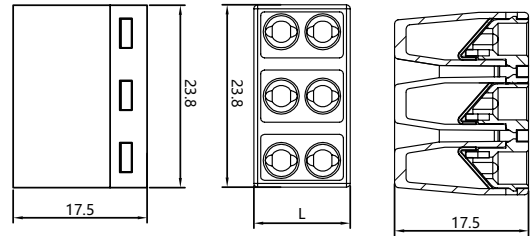

Reference No.	Color: Body case	Color: Terminal position	Hole	Amper	Voltage	Wire(mm ²)	L(mm)
KV230-302TC	Transparency	Colours	6	32	250/600VAC	0.75-2.5	12.6
KV230-303TC	Transparency	Colours	9	32	250/600VAC	0.75-2.5	18
KV230-304TC	Transparency	Colours	12	32	250/600VAC	0.75-2.5	23.4
KV230-305TC	Transparency	Colours	15	32	250/600VAC	0.75-2.5	28.8

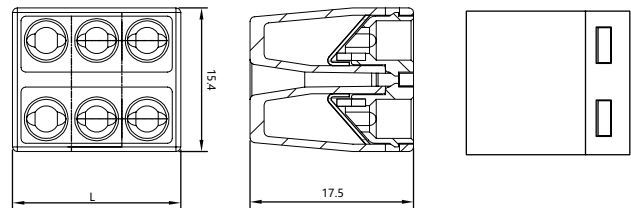
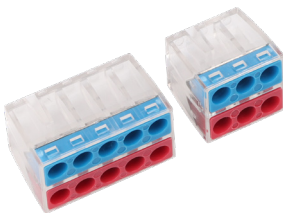

Reference No.	Color: Body case	Color: Terminal position	Hole	Amper	Voltage	Wire(mm ²)	L(mm)
KV230-202TC	Transparency	Colours	4	32	250/600VAC	0.3-2	12.6
KV230-203TC	Transparency	Colours	6	32	250/600VAC	0.3-2	18
KV230-204TC	Transparency	Colours	8	32	250/600VAC	0.3-2	23.4
KV230-205TC	Transparency	Colours	10	32	250/600VAC	0.3-2	28.8

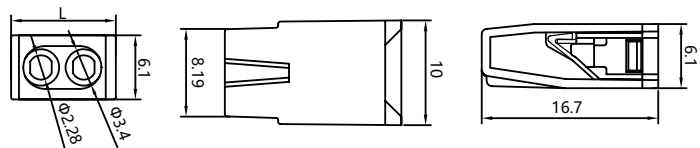

Reference No.	Color: Body case	Color: Terminal position	Hole	Amper	Voltage	Wire(mm ²)	L(mm)
KV202TO	Transparent	Orange	2	24	450VAC	0.75-2.5	9.8
KV203TW	Transparent	White	3	24	450VAC	0.75-2.5	13.8
KV204TR	Transparent	Red	4	24	450VAC	0.75-2.5	17.8
KV205TY	Transparent	Yellow	5	24	450VAC	0.75-2.5	21.8
KV206TR	Transparent	Red	6	24	450VAC	0.75-2.5	13.8
KV208TG	Transparent	Gray	8	24	450VAC	0.75-2.5	17.8

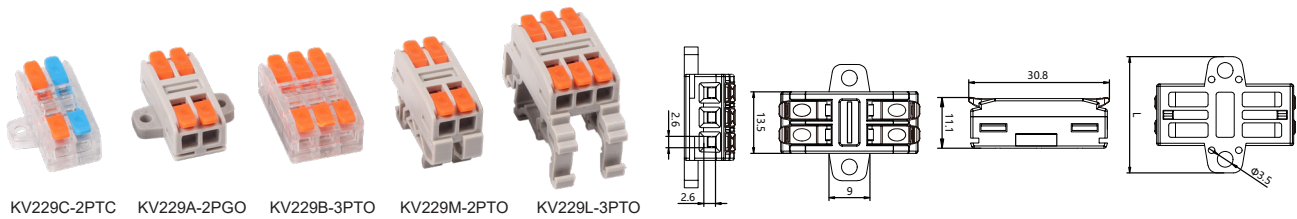

KV229C-2PTC KV229A-2PGO KV229B-3PTO KV229M-2PTO KV229L-3PTO

Reference No.	Color: Body case	Color: Terminal position	Hole	Amper	Voltage	Wire(mm ²)	L(mm)
KV229B-1PTG	Transparency	Green	2	32	300VAC	0.75-4	8.5
KV229B-1PTO	Transparency	Orange	2	32	300VAC	0.75-4	8.5
KV229B-1PTB	Transparency	Blue	2	32	300VAC	0.75-4	8.5
KV229B-1PTY	Transparency	Yellow	2	32	300VAC	0.75-4	8.5
KV229B-1PTB	Transparency	Black	2	32	300VAC	0.75-4	8.5
KV229B-1PGG	Gary	Green	2	32	300VAC	0.75-4	8.5
KV229B-1PGO	Gary	Orange	2	32	300VAC	0.75-4	8.5
KV229B-1PGB	Gary	Blue	2	32	300VAC	0.75-4	8.5
KV229B-1PGY	Gary	Yellow	2	32	300VAC	0.75-4	8.5
KV229B-1PGB	Gary	Black	2	32	300VAC	0.75-4	8.5
KV229M-1PTG	Transparency	Green	2	32	300VAC	0.75-4	8.5
KV229M-1PTO	Transparency	Orange	2	32	300VAC	0.75-4	8.5
KV229M-1PTB	Transparency	Blue	2	32	300VAC	0.75-4	8.5
KV229M-1PTY	Transparency	Yellow	2	32	300VAC	0.75-4	8.5
KV229M-1PTB	Transparency	Black	2	32	300VAC	0.75-4	8.5
KV229M-1PGG	Gary	Green	2	32	300VAC	0.75-4	8.5
KV229M-1PGO	Gary	Orange	2	32	300VAC	0.75-4	8.5
KV229M-1PGB	Gary	Blue	2	32	300VAC	0.75-4	8.5
KV229M-1PGY	Gary	Yellow	2	32	300VAC	0.75-4	8.5
KV229M-1PGB	Gary	Black	2	32	300VAC	0.75-4	8.5
KV229L-1PTG	Transparency	Green	2	32	300VAC	0.75-4	8.5
KV229L-1PTO	Transparency	Orange	2	32	300VAC	0.75-4	8.5
KV229L-1PTB	Transparency	Blue	2	32	300VAC	0.75-4	8.5
KV229L-1PTY	Transparency	Yellow	2	32	300VAC	0.75-4	8.5
KV229L-1PTB	Transparency	Black	2	32	300VAC	0.75-4	8.5
KV229L-1PGG	Gary	Green	2	32	300VAC	0.75-4	8.5
KV229L-1PGO	Gary	Orange	2	32	300VAC	0.75-4	8.5
KV229L-1PGB	Gary	Blue	2	32	300VAC	0.75-4	8.5
KV229L-1PGY	Gary	Yellow	2	32	300VAC	0.75-4	8.5
KV229L-1PGB	Gary	Black	2	32	300VAC	0.75-4	8.5
KV229B-2PTG	Transparency	Green	4	32	300VAC	0.75-4	13.5
KV229B-2PTO	Transparency	Orange	4	32	300VAC	0.75-4	13.5
KV229B-2PTB	Transparency	Blue	4	32	300VAC	0.75-4	13.5
KV229B-2PTY	Transparency	Yellow	4	32	300VAC	0.75-4	13.5
KV229B-2PTB	Transparency	Black	4	32	300VAC	0.75-4	13.5
KV229B-2PTC	Transparency	Colours	4	32	300VAC	0.75-4	13.5

Reference No.	Color: Body case	Color: Terminal position	Hole	Amper	Voltage	Wire(mm ²)	L(mm)
KV229B-2PGG	Gary	Green	4	32	300VAC	0.75-4	13.5
KV229B-2PGO	Gary	Orange	4	32	300VAC	0.75-4	13.5
KV229B-2PGB	Gary	Blue	4	32	300VAC	0.75-4	13.5
KV229B-2PGY	Gary	Yellow	4	32	300VAC	0.75-4	13.5
KV229B-2PGB	Gary	Black	4	32	300VAC	0.75-4	13.5
KV229B-2PGC	Gary	Colours	4	32	300VAC	0.75-4	13.5
KV229A-2PTG	Transparency	Green	4	32	300VAC	0.75-4	25.5
KV229A-2PTO	Transparency	Orange	4	32	300VAC	0.75-4	25.5
KV229A-2PTB	Transparency	Blue	4	32	300VAC	0.75-4	25.5
KV229A-2PTY	Transparency	Yellow	4	32	300VAC	0.75-4	25.5
KV229A-2PTB	Transparency	Black	4	32	300VAC	0.75-4	25.5
KV229A-2PTC	Transparency	Colours	4	32	300VAC	0.75-4	25.5
KV229A-2PGG	Gary	Green	4	32	300VAC	0.75-4	25.5
KV229A-2PGO	Gary	Orange	4	32	300VAC	0.75-4	25.5
KV229A-2PGB	Gary	Blue	4	32	300VAC	0.75-4	25.5
KV229A-2PGY	Gary	Yellow	4	32	300VAC	0.75-4	25.5
KV229A-2PGB	Gary	Black	4	32	300VAC	0.75-4	25.5
KV229A-2PGC	Gary	Colours	4	32	300VAC	0.75-4	25.5
KV229C-2PTG	Transparency	Green	4	32	300VAC	0.75-4	19.48
KV229C-2PTO	Transparency	Orange	4	32	300VAC	0.75-4	19.48
KV229C-2PTB	Transparency	Blue	4	32	300VAC	0.75-4	19.48
KV229C-2PTY	Transparency	Yellow	4	32	300VAC	0.75-4	19.48
KV229C-2PTB	Transparency	Black	4	32	300VAC	0.75-4	19.48
KV229C-2PTC	Transparency	Colours	4	32	300VAC	0.75-4	19.48
KV229C-2PGG	Gary	Green	4	32	300VAC	0.75-4	19.48
KV229C-2PGO	Gary	Orange	4	32	300VAC	0.75-4	19.48
KV229C-2PGB	Gary	Blue	4	32	300VAC	0.75-4	19.48
KV229C-2PGY	Gary	Yellow	4	32	300VAC	0.75-4	19.48
KV229C-2PGB	Gary	Black	4	32	300VAC	0.75-4	19.48
KV229C-2PGC	Gary	Colours	4	32	300VAC	0.75-4	19.48
KV229M-2PTG	Transparency	Green	4	32	300VAC	0.75-4	13.5
KV229M-2PTO	Transparency	Orange	4	32	300VAC	0.75-4	13.5
KV229M-2PTB	Transparency	Blue	4	32	300VAC	0.75-4	13.5
KV229M-2PTY	Transparency	Yellow	4	32	300VAC	0.75-4	13.5
KV229M-2PTB	Transparency	Black	4	32	300VAC	0.75-4	13.5
KV229M-2PTC	Transparency	Colours	4	32	300VAC	0.75-4	13.5
KV229M-2PGG	Gary	Green	4	32	300VAC	0.75-4	13.5
KV229M-2PGO	Gary	Orange	4	32	300VAC	0.75-4	13.5
KV229M-2PGB	Gary	Blue	4	32	300VAC	0.75-4	13.5
KV229M-2PGY	Gary	Yellow	4	32	300VAC	0.75-4	13.5
KV229M-2PGB	Gary	Black	4	32	300VAC	0.75-4	13.5
KV229M-2PGC	Gary	Colours	4	32	300VAC	0.75-4	13.5
KV229L-2PTG	Transparency	Green	4	32	300VAC	0.75-4	13.5

Reference No.	Color: Body case	Color: Terminal position	Hole	Amper	Voltage	Wire(mm ²)	L(mm)
KV229L-2PTO	Transparency	Orange	4	32	300VAC	0.75-4	13.5
KV229L-2PTB	Transparency	Blue	4	32	300VAC	0.75-4	13.5
KV229L-2PTY	Transparency	Yellow	4	32	300VAC	0.75-4	13.5
KV229L-2PTB	Transparency	Black	4	32	300VAC	0.75-4	13.5
KV229L-2PTC	Transparency	Colours	4	32	300VAC	0.75-4	13.5
KV229L-2PGG	Gary	Green	4	32	300VAC	0.75-4	13.5
KV229L-2PGO	Gary	Orange	4	32	300VAC	0.75-4	13.5
KV229L-2PGB	Gary	Blue	4	32	300VAC	0.75-4	13.5
KV229L-2PGY	Gary	Yellow	4	32	300VAC	0.75-4	13.5
KV229L-2PGB	Gary	Black	4	32	300VAC	0.75-4	13.5
KV229L-2PGC	Gary	Colours	4	32	300VAC	0.75-4	13.5
KV229B-3PTG	Transparency	Green	6	32	300VAC	0.75-4	18.5
KV229B-3PTO	Transparency	Orange	6	32	300VAC	0.75-4	18.5
KV229B-3PTB	Transparency	Blue	6	32	300VAC	0.75-4	18.5
KV229B-3PTY	Transparency	Yellow	6	32	300VAC	0.75-4	18.5
KV229B-3PTB	Transparency	Black	6	32	300VAC	0.75-4	18.5
KV229B-3PTC	Transparency	Colours	6	32	300VAC	0.75-4	18.5
KV229B-3PGG	Gary	Green	6	32	300VAC	0.75-4	18.5
KV229B-3PGO	Gary	Orange	6	32	300VAC	0.75-4	18.5
KV229B-3PGB	Gary	Blue	6	32	300VAC	0.75-4	18.5
KV229B-3PGY	Gary	Yellow	6	32	300VAC	0.75-4	18.5
KV229B-3PGB	Gary	Black	6	32	300VAC	0.75-4	18.5
KV229B-3PGC	Gary	Colours	6	32	300VAC	0.75-4	18.5
KV229A-3PTG	Transparency	Green	6	32	300VAC	0.75-4	30.5
KV229A-3PTO	Transparency	Orange	6	32	300VAC	0.75-4	30.5
KV229A-3PTB	Transparency	Blue	6	32	300VAC	0.75-4	30.5
KV229A-3PTY	Transparency	Yellow	6	32	300VAC	0.75-4	30.5
KV229A-3PTB	Transparency	Black	6	32	300VAC	0.75-4	30.5
KV229A-3PTC	Transparency	Colours	6	32	300VAC	0.75-4	30.5
KV229A-3PGG	Gary	Green	6	32	300VAC	0.75-4	30.5
KV229A-3PGO	Gary	Orange	6	32	300VAC	0.75-4	30.5
KV229A-3PGB	Gary	Blue	6	32	300VAC	0.75-4	30.5
KV229A-3PGY	Gary	Yellow	6	32	300VAC	0.75-4	30.5
KV229A-3PGB	Gary	Black	6	32	300VAC	0.75-4	30.5
KV229A-3PGC	Gary	Colours	6	32	300VAC	0.75-4	30.5
KV229C-3PTG	Transparency	Green	6	32	300VAC	0.75-4	24.48
KV229C-3PTO	Transparency	Orange	6	32	300VAC	0.75-4	24.48
KV229C-3PTB	Transparency	Blue	6	32	300VAC	0.75-4	24.48
KV229C-3PTY	Transparency	Yellow	6	32	300VAC	0.75-4	24.48
KV229C-3PTB	Transparency	Black	6	32	300VAC	0.75-4	24.48
KV229C-3PTC	Transparency	Colours	6	32	300VAC	0.75-4	24.48
KV229C-3PGG	Gary	Green	6	32	300VAC	0.75-4	24.48
KV229C-3PGO	Gary	Orange	6	32	300VAC	0.75-4	24.48

Reference No.	Color: Body case	Color: Terminal position	Hole	Amper	Voltage	Wire(mm ²)	L(mm)
KV229C-3PGB	Gary	Blue	6	32	300VAC	0.75-4	24.48
KV229C-3PGY	Gary	Yellow	6	32	300VAC	0.75-4	24.48
KV229C-3PGB	Gary	Black	6	32	300VAC	0.75-4	24.48
KV229C-3PGC	Gary	Colours	6	32	300VAC	0.75-4	24.48
KV229M-3PTG	Transparency	Green	6	32	300VAC	0.75-4	18.5
KV229M-3PTO	Transparency	Orange	6	32	300VAC	0.75-4	18.5
KV229M-3PTB	Transparency	Blue	6	32	300VAC	0.75-4	18.5
KV229M-3PTY	Transparency	Yellow	6	32	300VAC	0.75-4	18.5
KV229M-3PTB	Transparency	Black	6	32	300VAC	0.75-4	18.5
KV229M-3PTC	Transparency	Colours	6	32	300VAC	0.75-4	18.5
KV229M-3PGG	Gary	Green	6	32	300VAC	0.75-4	18.5
KV229M-3PGO	Gary	Orange	6	32	300VAC	0.75-4	18.5
KV229M-3PGB	Gary	Yellow	6	32	300VAC	0.75-4	18.5
KV229M-3PGY	Gary	Black	6	32	300VAC	0.75-4	18.5
KV229M-3PGB	Gary	Colours	6	32	300VAC	0.75-4	18.5
KV229M-3PGC	Transparency	Green	6	32	300VAC	0.75-4	18.5
KV229L-3PTG	Transparency	Orange	6	32	300VAC	0.75-4	18.4
KV229L-3PTO	Transparency	Blue	6	32	300VAC	0.75-4	18.4
KV229L-3PTB	Transparency	Yellow	6	32	300VAC	0.75-4	18.4
KV229L-3PTY	Transparency	Black	6	32	300VAC	0.75-4	18.4
KV229L-3PTB	Transparency	Colours	6	32	300VAC	0.75-4	18.4
KV229L-3PTC	Gary	Green	6	32	300VAC	0.75-4	18.4
KV229L-3PGG	Gary	Orange	6	32	300VAC	0.75-4	18.4
KV229L-3PGO	Gary	Blue	6	32	300VAC	0.75-4	18.4
KV229L-3PGB	Gary	Yellow	6	32	300VAC	0.75-4	18.4
KV229L-3PGY	Gary	Black	6	32	300VAC	0.75-4	18.4
KV229L-3PGB	Gary	Colours	6	32	300VAC	0.75-4	18.4
KV229L-3PGC	Transparent	Orange	4	32	300VAC	0.75-4	18.4

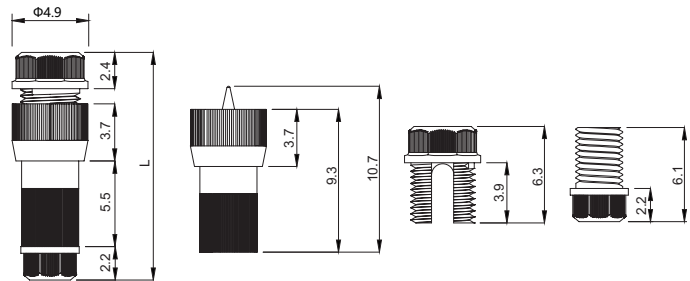

Reference No.	Color: Body case	In Wire(mm ²)	Out Wire(mm ²)	Hole	Amper	Voltage	L(mm)
KVCP-1B	Black	1.3-3.3	0.5-0.8	2	5	220VAC	37
KVCP-1BU	Blue	1.3-3.3	0.5-0.8	2	5	220VAC	37
KVCP-1R	Red	1.3-3.3	0.5-0.8	2	5	220VAC	37
KVCP-1Y	Yellow	1.3-3.3	0.5-0.8	2	5	220VAC	37

Parallel Terminal

Standard_ IEC455(1988)

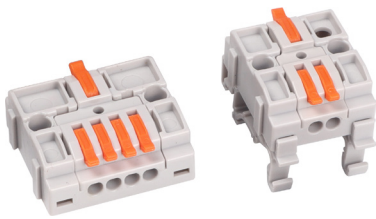

KV6414BGO

KV6412LGO

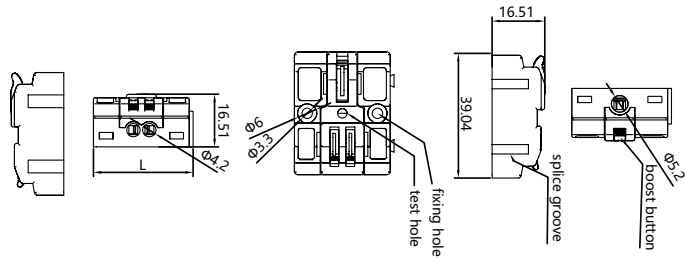

Reference No.	Color: Body case	Color: Terminal position	In Wire(mm ²)	Out Wire(mm ²)	Hole	Amper	Voltage	L(mm)
KV6412BGO	Gary	Orange	6	2.5-4	3	32	450VAC	31.2
KV6412LGO	Gary	Orange	6	2.5-4	3	32	450VAC	31.2
KV6413BGO	Gary	Orange	6	2.5-4	4	32	450VAC	36.2
KV6413LGO	Gary	Orange	6	2.5-4	4	32	450VAC	36.2
KV6414BGO	Gary	Orange	6	2.5-4	5	32	450VAC	41.2
KV6414LGO	Gary	Orange	6	2.5-4	5	32	450VAC	41.2
KV6415BGO	Gary	Orange	6	2.5-4	5	32	450VAC	46.2
KV6415LGO	Gary	Orange	6	2.5-4	6	32	450VAC	46.2



KVSF-15

KVF2002
KVF2003

KVF2505

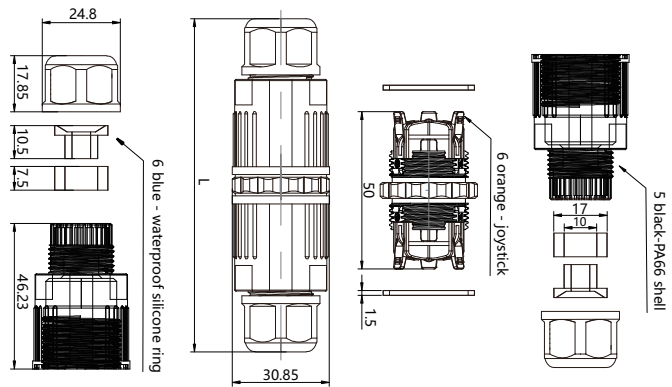

Reference No.	Color: Body case	IP	Hole	Amper	Voltage	Wire(mm ²)	L(mm)
KVSF-15	Black	68	4	16	250VAC	0.5-1.5	51
KVF2002-2P	Black	68	4	20	250VAC	0.5-1.5	97
KVF2002-3P	Black	68	6	20	250VAC	0.5-1.5	97
KVF2003-2P	Black	68	4	20	250VAC	0.5-1.5	97
KVF2003-3P	Black	68	6	20	250VAC	0.5-1.5	97
KVF2505-4P	Black	68	8	20	250VAC	0.5-1.5	115
KVF2505-5P	Black	68	10	20	250VAC	0.5-1.5	115

Tel-
0086-577-62780116

Fax-
0086-577-62774090

Email-
info@etek-china.com

No. 288 Wei 17th Road,
Economic Development Zone,
Yueqing City Zhejiang China.

ETEK[®]
E TEK ELECTRIC

ZHEJIANG ETEK
ELECTRICAL TECHNOLOGY CO.,LTD.

